

15 - 23 Gauge Staples

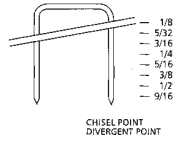

20 Gauge 3/8" or 1/2" Crown



(Similar to Rapid A 11
Duo Fast 5000)

20 Gauge 3/16" Crown

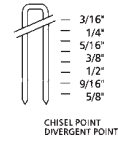

Similar to Duo Fast 5400

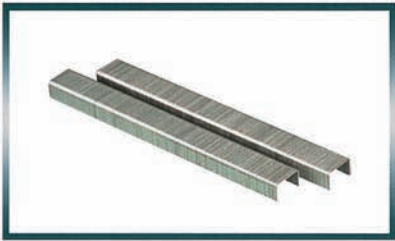

21 Gauge 1/2" Crown 22 Gauge 3/8" Crown 23 Gauge 3/8" Crown

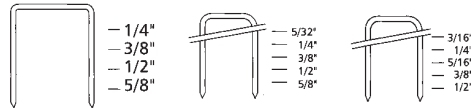

Similar to BeA80
Bostitch 81/86

Similar to Senco C,JK71,HB1400

Similar to Rapid A-19



20 Gauge 3/8" Crown

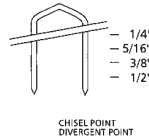

Similar to Bostitch
STCR5019.SHCR5019

20 Gauge

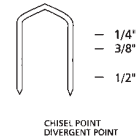

Similar to Bostitch
STCR2619



Staple Nailer 20 GA OR 23GA (J4,A)

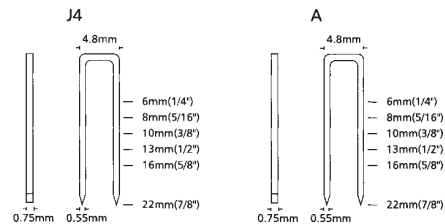

Similar to: Max J4
Galvanized Stainless Steel

Wide Crown Staple



16 Gauge 1" Crown

Similar to SENCO "P"
 Bostitch "Bcsw"
 Paslode "GSW"
 BeA "140"

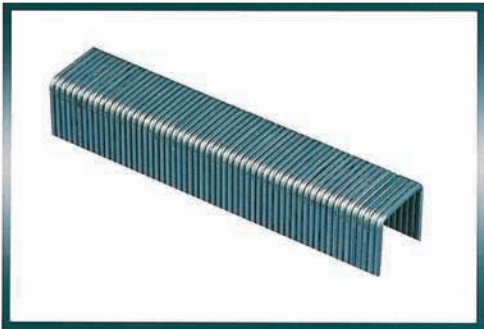
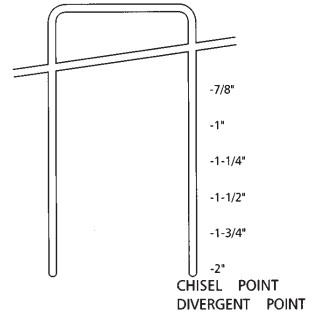

14 Gauge

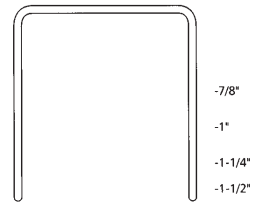

Medium Crown Staple

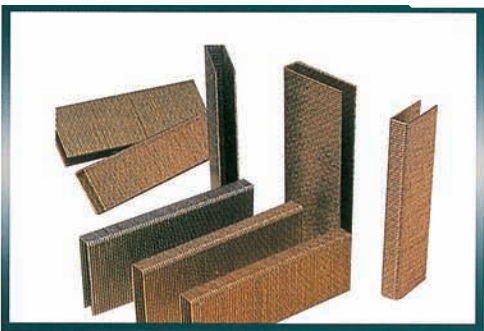

15 Gauge 1/2" Crown

16 Gauge 1/2" OR 7/16" Crown

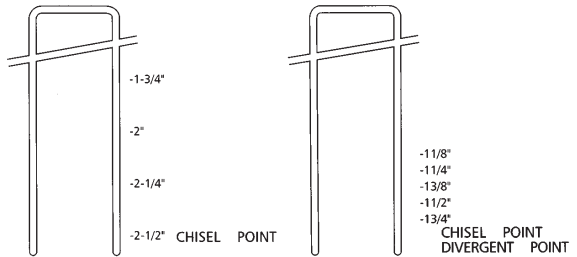

Similar to Bostitch, Hitachi, Paslode, Senco Staples

Narrow Crown Staple



18 Gauge 1/4" Crown

18 Gauge 3/8" Crown

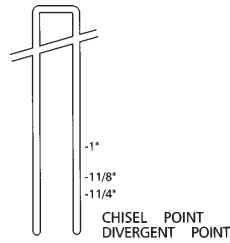

Similar to Bostitch, Hitachi, Paslode, Senco BeA staples

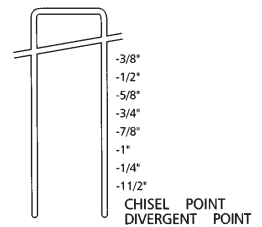

Similar to Senco M Staples